

# independent

living solutions

Multi-User Washrooms | Access Solutions | Equality Act Compliant Solutions | Multi-User Kitchens  
Grab Rails | Daily Living Products | Accessible Showering | Wetrooms | Wall and Floor Solutions

## Experience

Established in 1875, Nicholls & Clarke has pedigree that has been developed over many years. Through great heritage, we have gained a depth of knowledge and invaluable experience in the manufacturing and supplying of Phlexicare products to the construction market. We have experience across many industries with a huge portfolio of products suited to all project environments.

## Warranties

N&C Phlexicare products are manufactured to such high and exacting standards enabling us to offer a fantastic warranty on all our products.

## Environment

As an ISO14001 company, sustainability is a core part of our company agenda. As well as various carbon offsetting programmes in place, we invest a great deal in manufacturing and developing solutions dedicated to reducing our carbon footprint, and in turn increasing our customers' green credentials.



## British Manufacture

Our three state of the art U.K manufacturing facilities comply with ISO 9001 and ISO 14001, utilise the latest manufacturing technologies and apply stringent quality control checks during every part of the manufacturing process. Only the highest quality raw materials and packaging are used, ensuring the finished product meets our exacting standards.

## Customer Care

We aim to provide you with an outstanding level of customer service that will help to further enhance the service you offer to your clients. We monitor our performance levels and strive to achieve 100% client satisfaction. We believe that open channels of communication with our customers, coupled with their feedback are a sure way of further improving our customers buying experience.

## International

N&C Phlexicare products are used in over 70 countries throughout the world in some of the most demanding commercial situations. This worldwide experience has furthered the development of some of the latest technologies we now use in the U.K.

## Product Quality

All our products are tried and tested prior to being introduced into the marketplace. All N&C Phlexicare products exceed the requirements or the relevant BS/EN Standards, offering specification clients and contracting customers the confidence in our product quality.



## 24 Hour Nationwide Delivery

N&C Phlexicare are unique in being able to offer nationwide, next day delivery, even when you order up to 5pm the day before<sup>1</sup> and there is no minimum order requirement. N&C Phlexicare operates from 18 branches nationwide so can offer localised delivery, or with thousands of product lines in stock, you also have the option to collect.

## Trade Associations & Technical Committees

N&C Phlexicare has been heavily involved in the creation of British & European Standards for decades. We have chaired the TTA Wetroom Technical Committee. We continue to push for stringent policing of the industry which would stop manufacturers falsely claiming specific European standards on packaging. Our philosophy has always been to drive up quality and standards whilst remaining highly competitive.

## Disability Rights UK



## Technical Service

Our team of Phlexicare specialists are able to offer a full technical specification service and are available to attend any site address throughout the U.K. A technical written specification is available on request. We offer CAD drawings for easier

## Independent living, **inclusive** design

N&C Phlexicare are pioneering, British manufacturers and distributors of showering, daily living, access, wall & floor and kitchen solutions within the healthcare construction market. We design, manufacture and distribute a full range of inclusive solutions with users, carers and installers in mind.

Our products are inspirational by design, functional by nature and produced using high quality materials. Our passion is to enable freedom and independence for users with different levels of abilities, within commercial or domestic environments.

N&C Phlexicare invented many of the products taken for granted today, such as the raised height W.C pan, low entry shower tray and half height shower doors. Our commitment to research and development has led to the creation of many unique products which are specified and used throughout the U.K and exported worldwide.

One of Phlexicare's key core values is 'attractive, inclusive design' claimed by many but achieved by few. To that end, we work very closely with charities and organisations such as 'Disability Rights U.K', 'The Centre for the Accessible Environment', Occupational Therapists and disabled users to ensure that our products achieve solutions for all users and the people that care for them.





# Are you involved in adapt

As the leading independent living solutions providers in the UK, N&C Phlexicare supply the complete adaptations package for the ever increasing demand for projects for the elderly and disabled market. Order our 390 plus page independent living solutions catalogue for the full product listing, featuring over 6000 products for professionals.

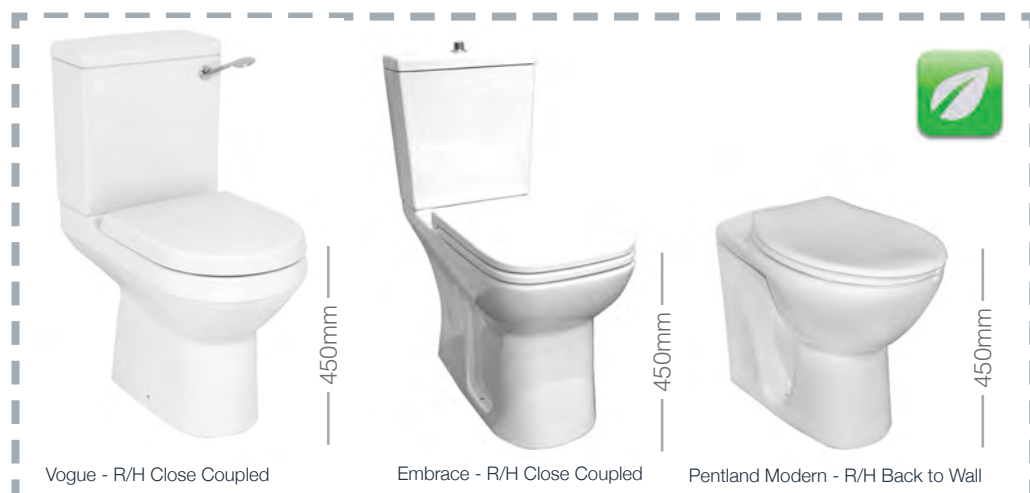

## Support Rails

Our collection of highly engineered grab rails and support systems have been ergonomically designed for a natural grip experience for extra comfort and grip. The Phlexi-wave has an anti-bacterial coating and wipe clean surface which is ideal for ease of daily use.



## Raised Height Toilet Pans

We supply a range of raised height pans (450mm), ideal for wheelchair transfer or users with a sensitive back or knees.

**Did you know that we invented Raised Height Pans back in the 1970's?**

## Advanced Toilet Seats

We supply a wide range of replacement toilet seats from standard seats to our most advanced toilet seats. Some of the special features incorporated in our advanced range include; retaining buffers, which are located within the rim of a W.C. pan to stop sideways movement during wheelchair transfer, strong stainless steel cross bar hinges for durability, antibacterial coatings to aid hygiene and soft close action for smooth seamless closing of the seat and cover.

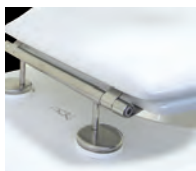
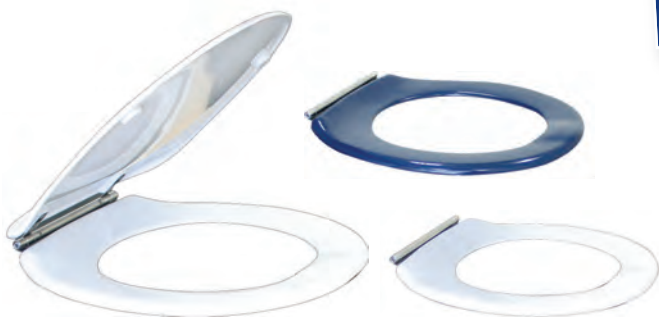

Designed for easy clean



Retaining buffer prevent lateral movement



Strong stainless steel cross bar hinge

# ation projects?

As part of the Nicholls & Clarke Group, we have the ability to offer the complete adaptation solution using a comprehensive range of quality products, so that you can benefit from dealing with one source, making it easier to co-ordinate project supplies: kitchens, bathrooms, to access and wall and floor solutions, we work with you to provide the complete solution for your project.

## Wash Basins for all

Our wash basins are manufactured to a high quality and tested rigorously prior to their availability in the market. We offer a variety of wash basins to suit users needs, such as our wall fixed models to allow ease of access for wheelchair users or an easy to use, moveable swing basin.

The majority of our wash basins, with bolt fixings, can also be mounted on adjustable height basin assemblies for multi-user environments. We offer a range of pedestal and semi-pedestal mounted basins in our range, with basins starting from 400mm to 760mm wide to suit the space available within the bathroom or washroom.



Wall mounted  
for ease of access



Height adjustable for  
multi-users



Pedestal mounted



Semi-pedestal mounted



## AquaClean 8000plus Care

The shower toilet system is perfect for those who wish to maintain independence and privacy in the bathroom. The shower toilet combines all the functions of a conventional W.C. and bidet with the comfort of warm-air drying.

## Taps & Mixers

Taps and mixers are the vital components which allow delivery of water to be achieved in all bathrooms. The operation of the taps and mixers within a healthcare or elderly person's bathroom or kitchen determines the ease of use, and therefore suitability of the fittings installed. Our lever tap collection allow users to operate the flow of water with ease.

We also offer thermostatic tap options to deliver safe water.



# Complete Adaptation Speci

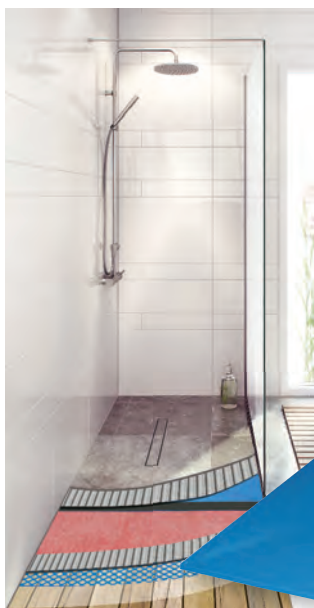

## Achieving Easy Access in the Bathroom

As British manufacturers we supply a collection of quality floor formers and shower trays available in endless sizes and shapes. All shower trays and decks meet stringent testing standards to ensure quality, strength and durability. For example, our Premier Shower Deck is a robust, self-supporting shower deck for achieving a total level access wet floor showering area with confidence. Tried and tested, the Premier Shower Deck is manufactured to high quality performance and endurance, accepting a weight of up to 470kg. The deck can be cut on site and has offset waste for easier and more flexible installation and can be installed onto concrete or timber floors.

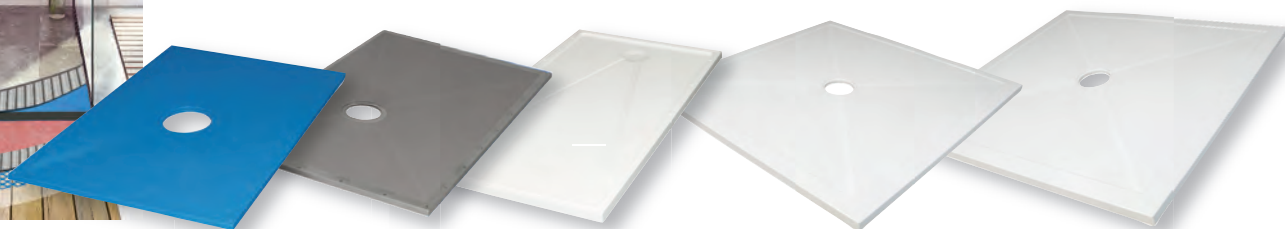
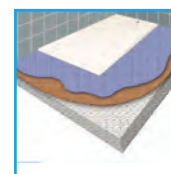
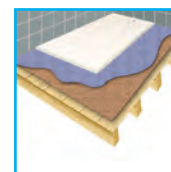

## Thermostatic, Anti-Scald Showers

N&C Phlexicare offer the most comprehensive range of both electric and thermostatic mixer showers with safety in mind. Hot water temperature is controlled and stabilised to avoid the potential for scalding. Thermostatic temperature stability, easy use controls, tactile raised areas and extended riser kits are some of the extra features provided in our electric shower offer. Whilst manufacturing our own dedicated healthcare mixer showers, we also work closely with brand leaders, such as Triton, Mira, Bristan and Redring to provide our customers with maximum choice.

TMV 3 - For use in high risk environments, hospitals, nursing homes and schools.

TMV 2 - Domestic homes, housing associations, local authorities, housebuilders and hotels.



## Half Height Doors

Our half height doors are the ideal solution for care assisted showering, with complete easy level access for family members and carers. These doors are available in a variety of configurations and sizes to suit all needs and requirements.

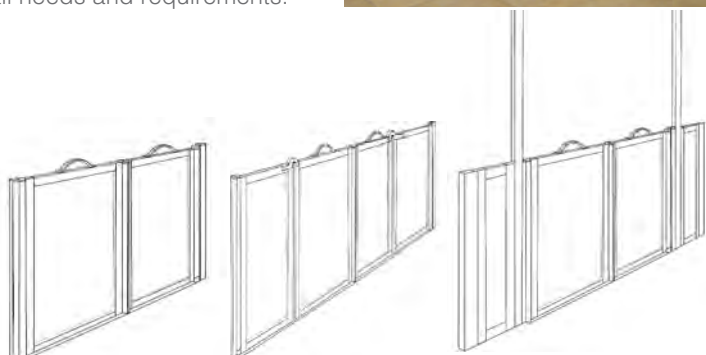

## Pumped Waste Systems

Our pump systems offer a variety of options to suit most installations where gravity drainage is not practical. Our shower waste pumps are extremely quiet and will easily cope with the output of all electric showers and most mixer valves.



## Gravity Waste Systems

A unique design of top access, combined waste and trap, for easy cleaning and maintenance.

# alists



## Flexible and Angled Shower Curtain Tracks

A flexible white coated aluminium shower curtain track is supplied as a straight section to be used between walls or can alternatively be easily bent into shape on site for corner installations. Tracks are supplied complete with 610mm adjustable ceiling support, easy glide rollers and 12 hooks.

## Shower Seats

Our range of shower seats can be used in many varied showering applications, both inside and outside the showering area. As these seats are wall mounted consideration should be given to the type of fixings used to secure them. The appropriate fixings (not supplied) to suit the wall construction should be used and advice is available from your local depot.



## N&C Installer Training

We offer practical training courses at our 120,000 square foot head office facility. Our team of experts will demonstrate and give clients and customers the opportunity to get hands on with our range of products.



For further information contact your local depot or head office on 020 8586 4600



## Safety Flooring Ikon Wet room Safety Vinyl Sheet

### Dove White WV759

A carefully textured dimpled surface specifically designed for safety with wet, bare feet or soft soled footwear. It affords superb slip resistance when wet.

# Multi-User Kitchens for all

## Height Adjustable Units and Worktops

N&C Phlexicare Kitchens ensure that everyone in a household, classroom or place of work can participate in daily activities on an equal basis and feel secure. Being able to adjust the height of worktops and wall cupboards is a great help for many people. The design of height adjustable worktops vary dependent on the building and the users needs.

Our Indivo collection consists of a range of height adjustable manual or electric, wall or floor standing work tops and tables. The Indivo manual & electric frames for freestanding worktops and tables can be used in areas where the wall structure is not strong enough to support our wall mounted models.



## Hassle Free Multi-User Kitchens

N&C Phlexicare believe that every kitchen should be inclusive in design to suit all user needs and abilities, with an equal emphasis on function, style and affordability. Our experienced, expert team are fully equipped to carry out a free comprehensive assessment and site survey to ensure the adapted kitchen is safe, functional and suited to all users within the household. Special unique features means that practical function can be combined with stylish design to match all budgets and tastes.



## Manufacturing excellence for safety

Our cabinet carcasses are constructed from a high quality, 18mm thick melamine board, available in a range of colour co-ordinated finishes. The units are glued and dowelled to give a solid pre-assembled construction. Available in both white and co-ordinated carcass colours.

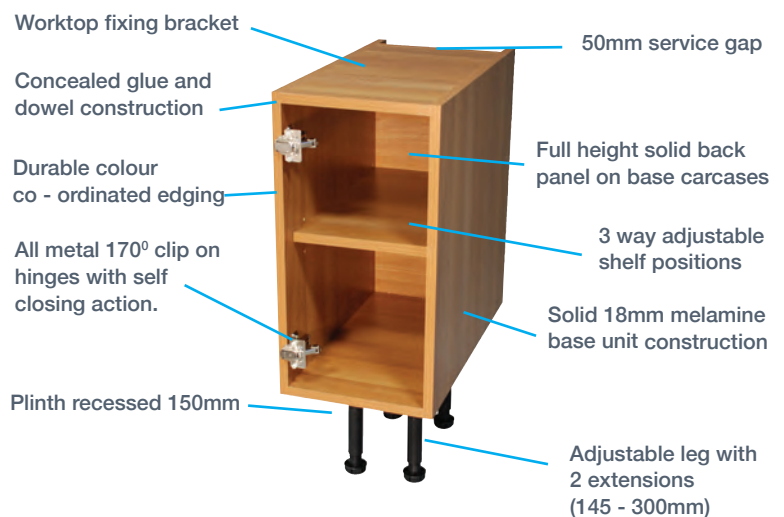





## Specialists in Compliant Accessible Toilets

Our fully compliant 'MPack' has been ergonomically designed with safety and comfort of users in mind. Our most comprehensive 'MPack' comes complete with TMV3 approved thermostatic mixer and co-ordinated accessories, whilst also offering visual contrast for visually impaired users for safe and easy manoeuvring. We offer a wide range of transfer possibilities to suit individual requirements, to ensure full compliance with both the Building Regulations Approved Document M 2015 Edition and BS 8300 2009 +A1 :2010.

## Washroom Accessories

We supply a broad range of washroom accessories from soap dispensers and hand dryers to, unique wet room ventilation systems. We cater to all budget requirements from basic shower adaptations to high end washrooms.



## Access and Portable Ramps

Our range of portable ramps are the perfect access solution for wheelchair users, where a permanent facility is unavailable. Our portable ramps can be used in both commercial and domestic settings with a number of uses, dependent on type of access requirements.



## New generation Official RADAR Lockset

N&C Phlexicare are the official manufacturers of The National Key Scheme (NKS) RADAR lock system. The scheme enables disabled people to independently access locked public toilets around the country. The scheme helps in the prevention of vandalism and misuse of public disabled toilets. Our locks have been rigorously tested for durability and meets requirements set out in BS8300.

# Install a Complete Wet Room in five easy steps...

**1**

## Wet Floor Former

Our Premier Shower Deck is an easy to install, robust floor former that can be tiled or vinylled directly onto. It creates a level access floor into the shower area & assists the flow of water to the drain

**2**

## Drainage

Opt for either standard or linear drainage with a tile insert option, or from a selection of our stylish stainless steel gratings

**3**

## Tanking System

Create a watertight environment with total confidence by using our complete tanking system which includes easy to use self adhesive collars and waterproof tape

**4**

## Shower Screens

Select from our attractive range of modern, toughened shower screens available in a range of sizes for any room size

**5**

## Tiles & Accessories

Choose from our huge range of on-trend wall & floor tiles, undertile heating, shower seat, grab rails and bathroom accessories



## The NEW All-in-One Bath Replacement Cubicle

AquaMagic is our revolutionary range of self contained shower cubicles, that encompasses innovation, style and performance. Designed with users in mind, AquaMagic features a cool touch shower, leak free construction as well as the option of an anti slip tray, secure grab rails and a comfortable fold down seat. Furthermore, the easy installation means that replacing an old bath or shower is easier than ever before.

### AquaMagic

- Inclusive, attractive design
- Toughened safety glass
- Anti-limescale treatment
- Leak-free showering
- 30mm low profile tray for easy accessibility
- Cool to touch, thermostatic shower
- Anti-slip finish on tray option
- Integrated shower seat
- Integrated support bar
- Suitable for corner or recess installation
- Fuss free, easy installation

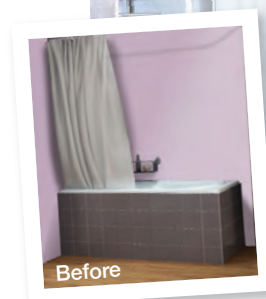

## Replace an existing bath in a day

# Create Rooms with Colour Contrast

Light Reflective Values (LRV)  
available for every tile!



## Ikon Plain Colour Wall Tile Range

The characteristics of ceramic tiles makes them an easy to maintain, hygienic wall covering option. Our N&C Ikon plain colour collection is the longest established plain colour wall tile range in the UK. With over 40 colours, 5 popular sizes, multiple finishes and high stain resistance, we offer an unrivalled solution to local authorities, housebuilders, housing associations and a wide range of other residential and commercial projects. With huge stocks and immediate availability, we are the preferred supplier to our customers all over the UK.



## Bevelled Gloss Wall Tiles

A popular choice in the residential market, these eye-catching, vibrant bevel edge ceramic wall tiles are suitable for use in the bathroom, kitchen or throughout the home for the ultimate in city chic.

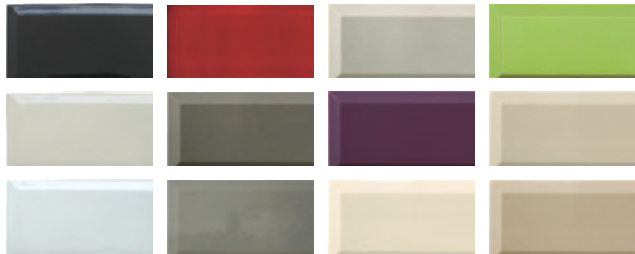

## Ikon Co-ordinating Vinyl Floor Tiles 300 x 300mm

Nicobond Ikon Vinyl Tiles are a multipurpose, durable, semi flexible vinyl floor tile. The tile has an excellent wear rating and with its PU coating makes it the perfect choice for schools, residential, offices, shops etc.

The range consists of 16 popular colours, 10 marble and 6 minimal design. Nicobond vinyl tiles are particularly suited for use in domestic housing and general refurbishment. The Nicobond Ikon Vinyl Floor Tiles have been designed to co-ordinate perfectly with the Nicobond Ikon Plain Colour Range of ceramic wall tiles.

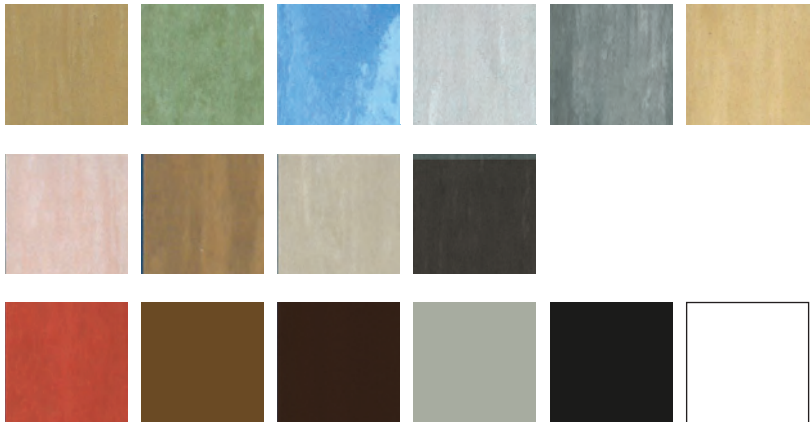



## Showering Solutions

We offer a comprehensive range of showering products for a wide range of applications from commercial to domestic. We offer installers and other professionals complete shower adaptation solutions for the creation of a more accessible environment for the end user.

We offer a vast number of sizes, configurations and types of trays and doors suited to the exacting needs of the user. Our range of shower doors include half-height bi-fold, tri-fold, front entry, corner entry, sliding and fixed panel options and more. We provide all shower accessories required to complete the project with products designed to be affordable, easy to install and attractive.

- Shower Trays
- Shower Doors
- Shower Packs
- Electric Showers
- Thermostatic Mixers
- Shower Raiser Rail Kits
- Gravity Shower Wastes
- Pumped Shower Wastes
- Shower Seats
- Shower Curtains and Track



### Anti-Microbial Protection

All of our shower trays are impregnated using the Wells Silver Ion System. This is a non organic system, which will not lose its effectiveness over time, as opposed to some other systems. The Wells Silver Ion System has proven effective against a large range of Gram Positive Bacteria such as Staphylococcus Aureus, MRSA, Listeria and Gram Negative Bacteria such as Escherichia Coli, Pseudomonas Aeruginosa and Salmonella. The additive is also effective against moulds and fungi such as Aspergillus Niger and penicillium Chrysogenum.

## Wet Room Solutions

N&C are unique as a manufacturer and supplier of all the components required to create a completely watertight, level access wet room with ease and confidence, without raising floor levels. Our floor formers have been manufactured, tried and tested proving to be the strongest shower decks in the UK market. Suitable for both tile and vinyl floor installations. We supply a range of options from glass screens, full and half height shower doors, sliding and pivot door options.

We manufacture the complete waterproof tanking system needed to provide a sealed, watertight environment, that is easy and quick to install.

- Floor Formers
- Shower Screens
- Wet Room Drainage
- Waterproofing and Tanking
- Wall and Floor Coverings (Tiles and Vinyl)





## Bathroom Solutions

Consideration of current requirements and future needs, intensity of use, and levels of dependency all need to be taken into account in the selection of products for the bathroom. N&C Phlexicare offer a wide range of solutions to suit varying requirements, from basic walk-in baths to the most complex powered baths. Furthermore, as manufacturers of sanitaryware we ensure the highest quality bathroom products are offered to our customers.

We supply eco products to meet stringent guidelines to reduce water consumption. Toilet pans vary from the simple replacement BSS type through to shower toilets with spray washing and drying function. All of this can be complimented with matching basins and taps to suit every budget.

- Baths
- W.C. Suites
- Wash Basins, Pedestals & Fixings
- Shower Toilets
- Toilet Seats
- Toilet Surrounds
- Taps, Mixers and Valves

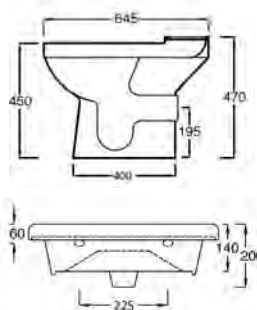
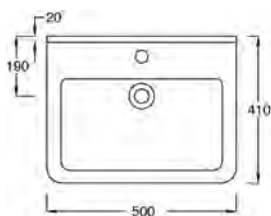

## Multi-User Solutions

We supply a wide range of Ropox and Pressalit and Hewi multi-user products that enable flexibility and freedom to adapt facilities fast to suit multi-user requirements. A standard hotel bathroom for example, can be converted simply and quickly into a bathroom suitable for each individual disabled person's requirements.

The unique track system can also be used in areas to temporarily accommodate differing clients at short notice without the need for permanent, expensive building work.

- Pressalit CareSystems plus
- Pressalit CareCompletion
- Pressalit CareElements
- Hewi Bathroom Systems
- Ropox Bathroom Systems

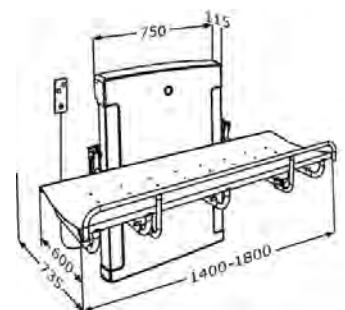
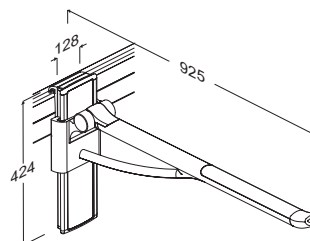

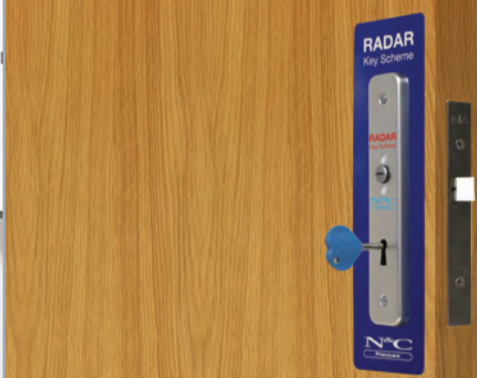

## Document M Solutions

## Access Solutions

N&C Phlexicare offer an unrivalled approach to 'Doc M' solutions for accessible toilets. We are market leaders in the provision of toilet facilities compliant with BS 8300 and requirements set out in the Equality Act 2010.

Our portfolio of solutions incorporates every design feature required by the latest editions of BS8300 2:2009, with options varying from those seeking cost control to clients looking for a Doc M package to suit their corporate environment. the Changing Places MPack is a recent addition that is required for public environments.

- BS 8300
- Compliance Drawings
- White and Blue MPacks
- Corporate MPacks
- Economy MPacks
- Changing Places
- W.C. Showers

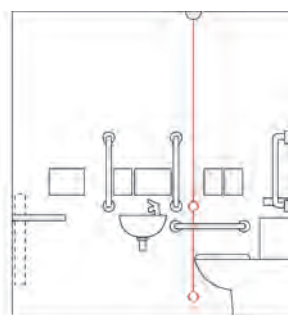

N&C Phlexicare are the official manufacturers of The National Key Scheme (NKS) RADAR lock system. The scheme enables disabled people to independently access locked public toilets around the country. The scheme helps in the prevention of vandalism and misuse of public disabled toilets. Toilets fitted with N&C Phlexicare RADAR National Key Scheme (NKS) locks can now be found in shopping centres, pubs, cafés, department stores, bus and train stations and many other locations across the country.

Our locks have been rigorously tested for durability and meets requirements set out in BS8300. We provide a range of access solutions including portable ramps that assist in providing access to buildings, and movement within them, possible and practical.

- Window Systems
- Door Systems
- Signage
- Portable Ramps

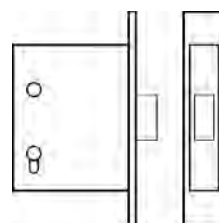

### Research & Development

Our product development team are highly equipped and constantly engaged in research and development. Investment in the latest testing facilities allow us to push forward with the development of the next new technology or raw material, that will further enhance product performance. Prior to going to market, we carry out rigorous testing to ensure that our products' performance is to a consistently high standard. Our products undergo thorough testing to meet the relevant standards and regulations. We also test our competitors products to ensure our products remain best in class.



## Daily Living Solutions

We offer a variety of daily living products that are essential to improving the independence and care of people with a diversity of requirements. We offer easy to install, highly functional and good quality products from 'warm to touch' grab rails for everyday support in a domestic setting, to soap dispensers and ventilators that are required in commercial environments.

We supply a range of anti ligature products for different categories of risk for people that are at risk of harm to themselves.

- Grab Rails
- External Handrail System
- Washroom Accessories
- Carer Screens
- Nursery Benches
- Mirrors
- Electrical Accessories
- Bathroom Ventilation
- Anti Ligature Solutions

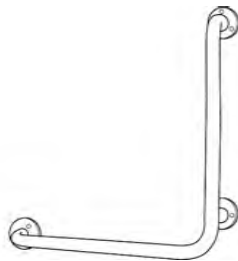
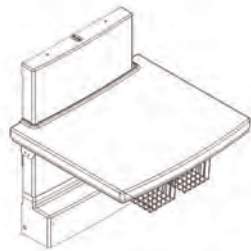

## Kitchen Solutions

N&C Phlexicare believe that every kitchen should be inclusive in design to suit all user needs and abilities, with an equal emphasis on function, style and affordability. Our experienced expert team are fully equipped to carry out a comprehensive assessment and site survey to ensure the adapted kitchen is safe, functional and suited to all users within the household.

Special unique features means that practical function can be combined with stylish design to match all budgets and tastes.

- Healthcare Kitchens
- Bespoke Design
- Doors & Cabinets
- Designer Handles
- Height Adjustable Worktops and Sinks
- Appliances

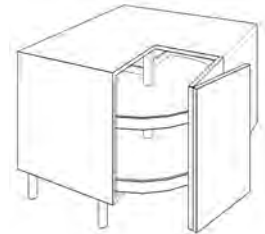

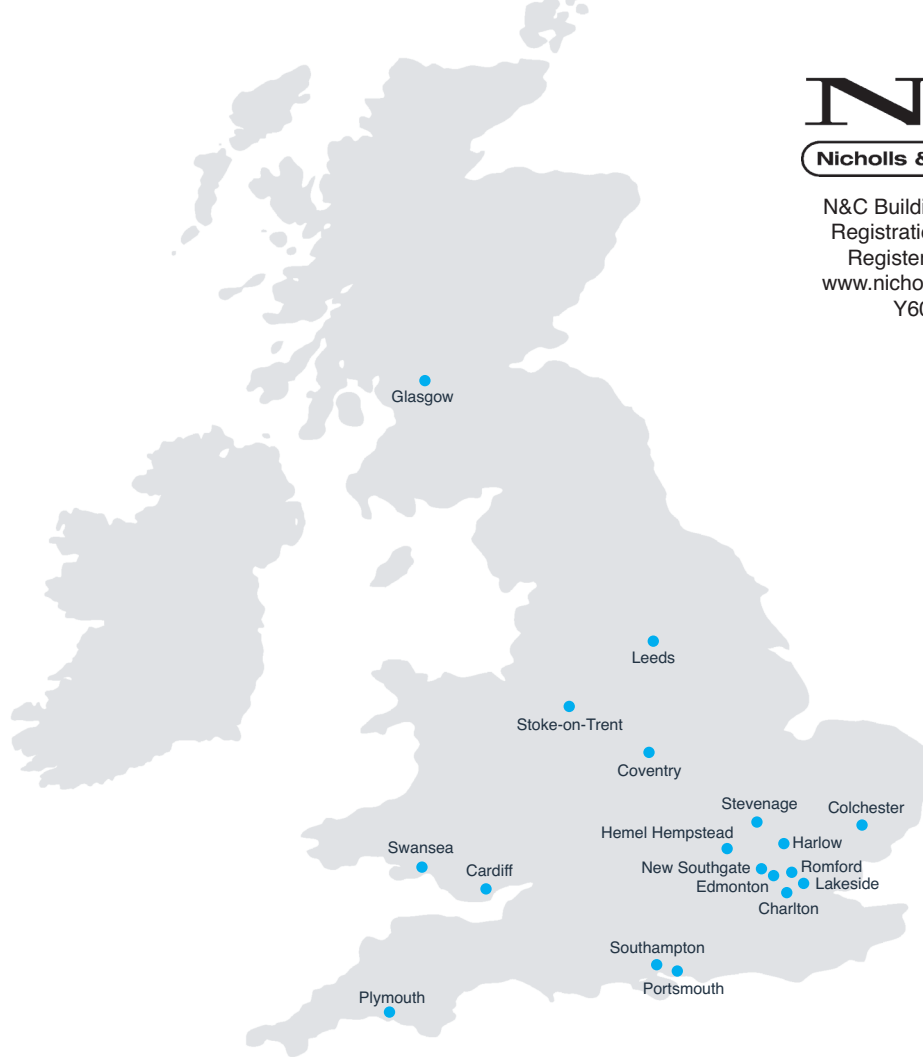

## Distribution Centres, Trade Counters & Showrooms

N&C Building Materials  
 41-51 Freshwater Road  
 Chadwell Heath

**Romford**, Essex RM8 1SP  
 Tel: 020 8586 4600  
 Fax: 020 8586 4646

Unit C1  
 Cothill Industrial Estate  
 Plympton, **Plymouth** PL7 1SR  
 Tel: 01752 339724  
 Fax: 01752 342746

Units B1/B3  
 Sneyd Trading Estate  
 Sneyd Hill, Burslem  
**Stoke-on-Trent**, ST6 2PA  
 Tel: 01782 575727  
 Fax: 01782 575641

26 Colquhoun Avenue, Hillington  
 Industrial Estate, Hillington  
**Glasgow**, Scotland G52 4BN  
 Tel: 0141 880 1200  
 Fax: 0141 880 1212

Units 3 & 4  
 Cardiff Trade Park, Hadfield Road  
**Cardiff**, CF11 8AQ  
 Tel: 029 2039 0146  
 Fax: 029 2022 4356

Unit 4  
 Waterloo Industrial Estate  
 Flanders Road, Hedge End  
**Southampton**, SO30 2QT  
 Tel: 01489 779700  
 Fax: 01489 779701

**Nicholls & Clarke**  
 Est 1875

## Trade Counters & Showrooms

Units 1A/B Alexander Place  
 Lower Park Road  
**New Southgate**, London N111ST  
 Tel: 020 8361 6050  
 Fax: 020 8361 4757

Unit 14, Meridian Trading Estate  
 Bugsby Way, **Charlton**,  
 London SE7 7SJ  
 Tel: 020 8269 5960  
 Fax: 020 8269 5961

Units 10, 11, 14 & 15  
 Advent Business Park  
 Advent Way, **Edmonton**, N18 3AF  
 Tel: 020 8807 3227  
 Fax: 020 8807 3223

Unit 8, Ascent Park  
 Edinburgh Way  
**Harlow**, Essex CM20 2HW  
 Tel: 01279 621980  
 Fax: 01279 621981

Unit 1 Cliffside Trade Park  
 Motherwell Way, **Lakeside**  
 West Thurrock, Essex RM20 3XD  
 Tel: 01708 680180  
 Fax: 01708 680181

2 - 3 Altbar Close,  
 Wyncolls Road, Severalls Park  
**Colchester**, Essex CO4 9HY  
 Tel: 01206 849300  
 Fax: 01206 845878

Unit 9 - 11, McDonald Business Park  
 Maylands Avenue, **Hemel Hempstead**  
 Hertfordshire HP2 7EB  
 Tel: 01442 234635  
 Fax: 01442 279501

Unit 8D, Pompey Centre,  
 Fratton Way, Southsea  
**Portsmouth**, PO4 8TA  
 Tel: 02392 894599  
 Fax: 02392 894598

25 Gunnels Wood Park  
 Gunnels Wood Road, **Stevenage**,  
 Hertfordshire SG1 2BH  
 Tel: 01438 315400  
 Fax: 01438 740338

Unit 5 Tower Court  
 St. David's Road, Swansea  
 Enterprise Park, **Swansea** SA6 8QL  
 Tel: 01792 797337  
 Fax: 01792 774019

Unit 2 City Park Industrial Estate,  
 Gelderd Road, **Leeds** LS12 6DR  
 Tel: 0113 263 4070

**NEW STORE**  
 Leofric House, Off Phoenix Way  
 Waterman Road  
**Coventry**, CV6 5TP  
 Tel: 02476 705300  
 Fax: 02476 705301